

# Automation PC

## Quick Guide for NP-6116 series Industrial PC

1

You will find the specifications, interface definition and how to use the product from this quick guide. Please read and learn this guide carefully before power on, for the I/O development Kit, please contact sales or local reseller.

Please keep this guide properly for future reference and be sure to share for the end user.

## 1. Safety Precautions

- Please read and follow the safety precautions before you are going to use it.
- Pay attention to the labels on the product.
- The "Tips", "Warnings" and "Danger" items in the following table don't represent all safety precautions to be followed, but only the supplementary.
- Make sure to use in an environment that meets the design specifications, otherwise, malfunction or partial damage caused by non-compliance with relevant regulations is not covered under the product quality guarantee.
- Please unplug the power cord and do not use liquids to clean the PC.
- Please keep the PC in a safe space to prevent it from falling and damaging its components.
- Please keep the power cord in a safe location to avoid causing personal injury.
- Please do not bundle control wires, communication cables and power wires together, it would be better to keep a distance of at least 100mm between them to avoid mutual interference.
- It is recommended to use wires with isolation, especially in environments with severe electromagnetic interference.
- Please disconnect it from the power socket if the PC is not used for a long time.
- Please make sure that no liquids enter the device to avoid the risk of fire or short circuit.
- Please disconnect the power cord before opening the computer case.
- Please clean the dust regularly.
- Please ask for technical support and return the PC to RMA:
  - The power cord or plug is damaged;
  - Liquid has entered the interior of the PC;
  - PC doesn't work;
  - PC is damaged;

## Safety Instrcutons

Symbols	Description
	Warning: There are potentially dangerous situations that if not avoided will result in death, serious injury or significant property damage.
	Danger: There are imminently dangerous situation that if not avoided will result in death, serious injury or significant property damage.
	Tip: There are important information tips.

## 2. Product information

### 2.1. Specification

Model Name	NP-6116-J1900	NP-6116-J6412
CPU	Intel® Celeron J1900, 2.0-2.42GHz, 4 Cores, 4 Threads, 2MB L2 Cache	Intel® Celeron J6412, 2.0-2.6GHz, 4 Cores, 4 Threads, 1.5MB L2 Cache
TDP	10W	
BIOS	AMI UEFI 64Mbit	AMI UEFI 256Mbit
Memory	1 x SO-DIMM DDR3L-1333MHz, Support up to 8GB	1 x SO-DIMM DDR4-3200MHz, Support up to 32GB
Storage	1 x M.2-2242 M key SSD Slot, SATA2.0	1 x M.2-2242 M key SSD Slot, SATA3.0/PCIe3.0
USB	1 x USB3.0, 2 x USB2.0	3 x USB3.1
COM	1 x RS-232, 1 x RS-485	
Ethernet	1 x Intel i210/211AT GbE LAN 2 x RTL8111H GbE LAN	3 x Intel i210/211AT GbE LAN
DP	Support up to 2560 x 1600 @60Hz	Support up to 4096 x 2160 @60Hz
HDMI	Support up to 1920 x 1080 @60Hz	Support up to 3840 x 2160 @60Hz
Expansions	1 x Full-size miniPCIe slot with SIM card holder	
DO	1 x Programmable LED	
Watch Dog	1~255 levels programmable	
OS	Windows 7/10	Windows 10/11
OS	Ubuntu, CentOS, Debian	
Voltage Input	DC12~24V ±10%, overcurrent, overvoltage and polarity inverse protection	
Power Consumption	Max.45W	
Dimensions	(L)138mm x (W)102mm x (H)48mm	
Net Weight	1.06Kg	
Work Temperature	-20°C ~ 60°C (SSD)	
Stroage Temperature	-20°C ~ 60°C (SSD)	
Relative Humidity	5~95%(Non-condensing)	
Operating Vibration	5~500Hz, 1.5Grms@with SSD, Follow IEC60068-2-64	
Operating Shock	20G peak acceleration (11ms duration) with SSD, Follow IEC60068-2-27	
EMC	CE/FCC Class B	

## 2.2. Interface specification

2

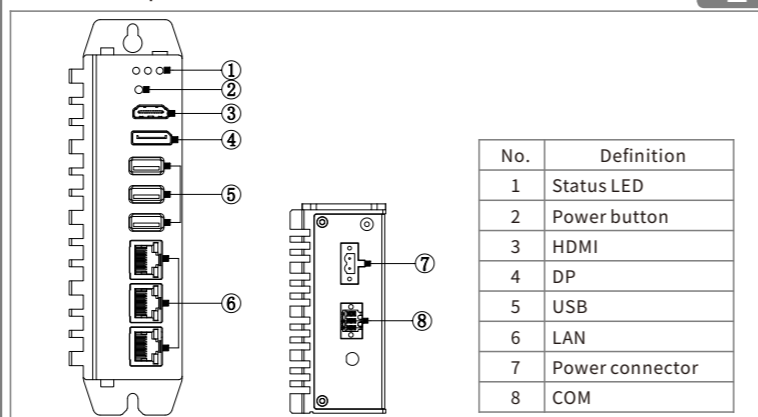

## 2.3. Interface description

No.	Name	Functional definition	Description
1	Status LED	The status indicator are Power led, HDD led and PL LED. LED Name      status      Description Power LED      off      The product is power off on (Green)      The product is power on PL LED      Red/Green/off      Use programmable led HDD LED      blink (Orange)      The disk is reading or writing	
2	Power button	It is used to turn on or turn off.	
3	HDMI	HDMI display port      Type-A HDMI Connector Pin No.      Signal      Pin No.      Signal      Pin No.      Signal      Pin No.      Signal 1      DATA2+      6      DATA1-      11      CLK SHIELD      16      DATA 2      DATA2 SHIELD      7      DATA0+      12      CLK-      17      GND 3      DATA2-      8      DATA0 SHIELD      13      CEC      18      +5V 4      DATA1+      9      DATA0-      14      N.C.      19      HPD 5      DATA1 SHIELD      10      CLK+      15      CLK	①: HDMI to VGA converter can be used when VGA display is required.
4	DP	DP display port DP Connector Pin No.      Signal      Pin No.      Signal      Pin No.      Signal      Pin No.      Signal 1      DATA0+      6      DATA1-      11      DATA3 GND      16      AUX GND 2      DATA0 GND      7      DATA2+      12      DATA3-      17      AUX- 3      DATA0-      8      DATA2 GND      13      CONFIG1      18      HPD 4      DATA1+      9      DATA2-      14      CONFIG2      19      PWR RT 5      DATA1 GND      10      DATA3+      15      AUX+      20      PWR	① DP to VGA converter can be used when VGA display is required.
5	USB	USB3.1/USB3.0 Connector      Type A Pin No.      Signal      Pin No.      Signal 1      VCC5      6      SSRX+ 2      DATA-      7      GND 3      DATA+      8      SSTX- 4      GND      9      SSTX+ 5      SSRX- USB2.0 Connector      Type A Pin No.      Signal      Pin No.      Signal 1      VCC5      3      DATA+ 2      DATA-      4      GND	①: The IPC (J6412 CPU) provided three USB3.1 ports; the IPC (J1900 CPU) provided one USB3.0 port and two USB2.0 ports.
6	LAN	RJ 45 Connector      3 LAN ports LAN Link      Transmit      Pin No.      Signal      Pin No.      Signal 1      DA+      5      DC- 2      DA-      6      DB- 3      DB+      7      DD+ 4      DC+      8      DD- Name      Color      Description Link      Yellow      off: Unconnected on: Connected blink: Connected and the data is reading or writing Transmit      Orange      on:100Mbps connected Green      on:100Mbps connected	
7	Power connector	Phoenix Connector (5.08mm)      12-24V DC IN Power Pin No.      Signal      Pin No.      Signal 1      GND      2      DC12-24V	
8	COM	Phoenix Connector (3.5mm) COM Pin No.      RS-232 Signal      Pin No.      RS-485 Signal 1      GND      2      GND 3      TXD      4      B 5      RXD      6      A	

## 2.4. Dimension

3

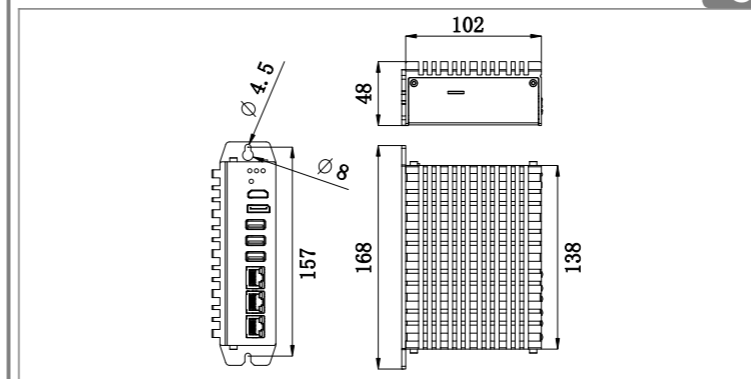

## 2.5. Connection and use

### 2.5.1. Phoenix terminal wiring

The power input interface and serial communication interface of NP-6116 series IPC adopt spring-type pressing terminals. Please connect according to the parameters in the table when using, otherwise it may lead to loose wiring, falling off or unstable communication.



Name	d(mm)	D(mm)	Rigid wire(mm <sup>2</sup> )	Flexibly wire(mm <sup>2</sup> )
DC IN Connector	10-11	12	0.5-2.5	0.5-2.5
COM Connector	7-8	10	0.2-1.0	0.2-1.5

### 2.5.2. Ethernet

The NP-6116 series IPC have 3 Ethernet ports, standard RJ-45 connector. The network cable is recommended to use a shielded network cable of Category 5 or above to ensure its working stability.

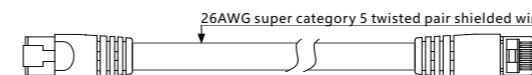

### 2.5.3. RS485 communication

The NP-6116 series IPC have 1 channel of RS-485 with phoenix terminal. The cable is recommended to use a shielded twisted pair and the shield should be connected to the ground properly by the single point. A120 ohm terminal resistor should be placed at the end of the cable for limiting bus reflections.

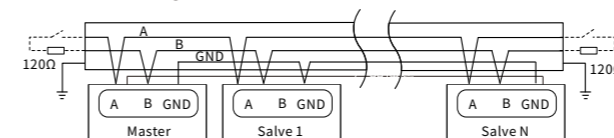

### 2.5.4. Power Supply

In order to make the IPC work more reliably, it is recommended to add a DC power filter between the IPC and the input power supply, and ensure that the filter and the IPC must be well grounded to prevent some interference problems.

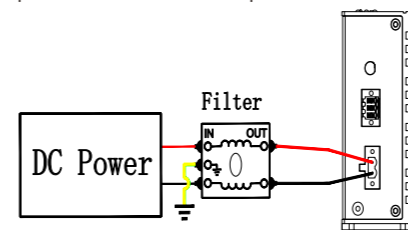

### 2.5.5. Memory card installation

Use a hexagonal screwdriver to remove the four screws (position 1-4 in Figure 1), open the rear case (position 5 in Figure 1), and insert the memory card into the slot (position 6 in Figure 1) at an angle of 30°, then press it in the direction of the arrow (Figure 1) until the card audibly latches into place. Lift up in the direction of the arrow (Figure 2) to remove the memory.

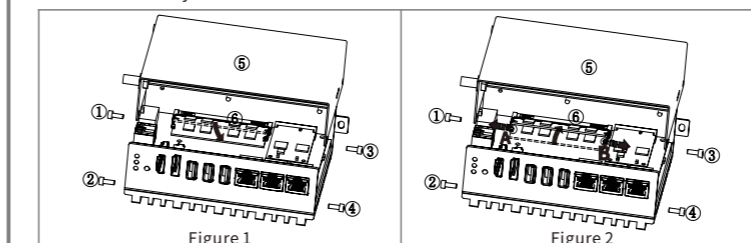

⚠: If the IPC is equipped with a SIM card, please remove the SIM card firstly, and then disassemble other parts.

### 2.5.6. 4G/Wifi card installation

Use a hexagonal screwdriver to remove the four screws (position 1-4 in Figure 1), open the rear case (position 5 in Figure 1), and insert the expansion card into the slot (position 6 in Figure 1) at an angle of 30°, then press the expansion card in the direction

of the arrow (Figure 1), and fix it on the motherboard with a M2 screw, the antenna adapter cable is installed at position A (Figure 2), and the other end is installed at position B (Figure 2). After the card and cable are installed, the rear cover of the machine can be closed, and the external antenna and SIM card can be installed after locking all of the screws.

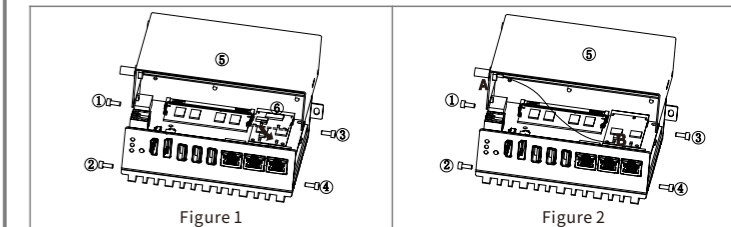

⚠: If the IPC is equipped with a SIM card, please remove the SIM card firstly, and then disassemble other parts.

### 2.5.7. SIM card installation

NP-6116 series IPC have a SIM card slot, and the SIM card can be installed and removed normally without dismantling the machine. When installing, push the SIM card into the card slot. And press the SIM card with a tool and the card will pop out when disassembling.

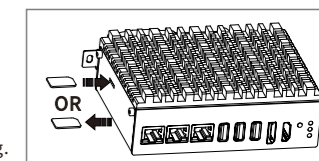

ⓘ: Please pay attention to the direction of the SIM card when installing the SIM card, otherwise, the SIM card will not be recognized.

## 2.6. IPC installation

The NP-6116 series IPC support wall mounted in default, and DIN-rail mounted is an option.

### 2.6.1. Ground wiring

The NP-6116 series IPC have a ground screw on the side of the power terminal, it is recommended to use thicker and shorter cable to connect to the ground nearby properly.

### 2.6.2. IPC installation space

In order to facilitate the installation and heat dissipation and ventilation of the IPC, a sufficient distance should be left between the IPC and the surrounding components. Figures of two installation methods:

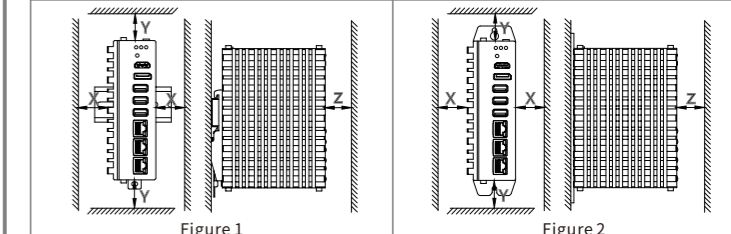

Direction	Minimum size (mm)
X	50
Y	100
Z	50

### 2.6.3. Wall mounted installation

There is a hanging plate on the back of the IPC, and there is a hole on the upper and lower sides of the hanging plate. The IPC can be fixed on the backboard through screws to realize the wall-mounted structure (Refer to Figure 1). Please refer to Figure 2 during disassembly. Please pay attention that the mounting screw pan head needs to be less than 8mm and greater than 4.5mm.

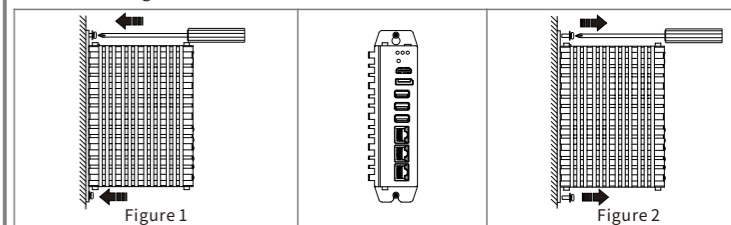

### 2.6.4. DIN-Rail mounted

NP-6116 series IPC also support DIN-Rail mounted as an option. Put the IPC in the normal mounting position, the IPC is mounted on the DIN rail from above. Make sure that the universal DIN rail adapter is in the correct position behind the DIN rail (A in Figure 1). Then press the IPC down until the universal DIN rail adapter audibly latches into place (B in Figure 1). Please make sure that the IPC is securely attached to the DIN rail. When disassembling, the steps are reversed, please refer to Figure 2 and Figure 3.

